

# Installation Guide

## 安装说明

INTELLIGENT TOILET ST20E

智能坐便器

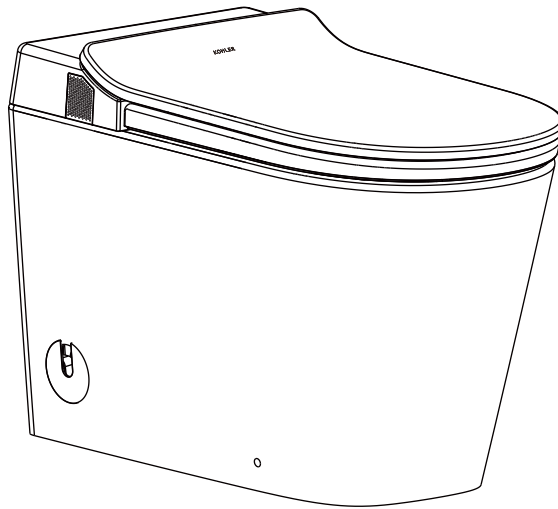
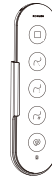

科勒（中国）投资有限公司

中国上海市静安区江场三路158号 邮编：200436

制造商：上海科勒电子科技有限公司

中国上海市宝山区丰翔路1955号 邮编：200444

English page 2-15

中文页码 16-29

1630418-T2-B

THE BOLD LOOK  
OF **KOHLER**®

## NOTE

 **WARNING:** Risk of electric shock for hardwires installations/through-floor electrical supply: Connect only to properly-grounded, dedicated 220V~, 50Hz, 10A circuit protected by a Class A Ground-Fault Circuit-Interrupter (GFCI) or Earth-Leakage Circuit-Breaker (ELCB).

 **DANGER:** Risk of electric shock. Disconnect power before using.

 **WARNING:** Risk of electric shock. Connect only to circuits protected by Ground-Fault Circuit-Interrupters (GFCI's) or Earth-Leakage Circuit-Breakers (ELCB's).

 **CAUTION:** Risk of hazardous gases. If a new toilet is not installed immediately, temporarily place a rag in the floor flange opening.

NOTICE: Follow all local plumbing and electrical codes.

NOTICE: Receptacles (if any) installed in bathrooms shall be located at least 1 meter from a bathtub or shower if practical.

- Observe all local plumbing and building codes.
- Carefully inspect the new toilet for damage.
- Water and electrical supplies may be wall mounted.

  **WARNING: 10A receptacle is required.**

## BEFORE YOU BEGIN

- Please read the following instructions carefully and familiarize yourself with the required tools, materials, and installation sequences. Follow the section that pertains to your particular installation. This will help you avoid costly mistakes. In addition to proper installation, please also read all operating and safety instructions.
- All information in the instructions is based upon the latest product information available at the time of publication. Kohler China reserves the right to make changes in product characteristics, packaging, or availability at any time without notice.
- These instructions contain important care, cleaning, and warranty information - please leave instructions for the consumer.
- We appreciate your commitment to Kohler quality. Please take a few minutes to review this manual before installation. If you encounter any installation or performance problem, please don't hesitate to contact us. Thanks again for choosing Kohler Company.
- Pre-arrange enough space for toilet installation. Make sure it will not affect the opening and closing of the door.
- When install the product in the room, a stop valve shall be installed in a close proximity. For emergency circumstances, the water inlet valve shall be stopped without using any tools; otherwise unexpected failure may cause the loss to the customer.
- Confirm discharge pit dimension distance is 305mm or 400mm. Rough-in distance should meet 295~350mm or 390~445mm. If not, the installation will be compromised.
- Confirm water supply stop must extend no more than 3mm beyond the finished wall or sink no more than 5mm below finished wall or the installation will be compromised.
- DN15mm or larger main water pipe is recommended.
- Do not use attachments not recommended by Kohler Co. such as angle valve etc.
- In order to achieve a better flush performance, customer shall avoid any obvious pipe necking or blockage from thermal melt during PPR pipe connection, and ensure ID no less than 15mm after connection.
- Recommended cable spec is 1mm<sup>2</sup>-2.5mm<sup>2</sup> hard wires; connect only to 220V~, 50Hz, 10A or more circuit protected with grounded circuit-breaker or grounded electric leak circuit breaker.
- When user cut power supply off, if reactivation of power supply is required, please wait until the end of "beep....." indication, and then turn on power supply again.
- The toilet must be grounded properly.
- Fixed wiring center must be equipped with electric shock opening so to disconnect the power completely when level III overload condition occurred.

## Tools and material (Not supplied)

Drill and bits, assorted screwdrivers (crosshead, flat and hex), wire stripper, scissor, socket wrench, utility knife, pen, pliers, tape, test pencil, PTFE tape

Others

Pad and protection material

Masking tape

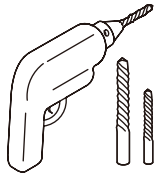

Drill and bits

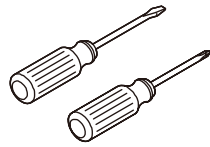

Screwdriver

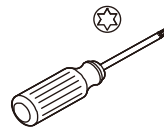

Hex head screwdriver

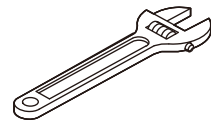

Socket wrench

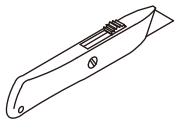

Utility knife



Pen

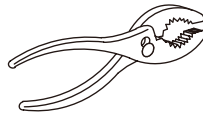

Pliers



Tape

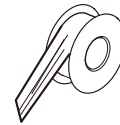

PTFE tape

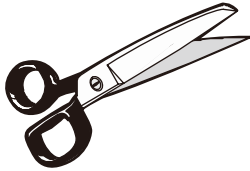

Scissor

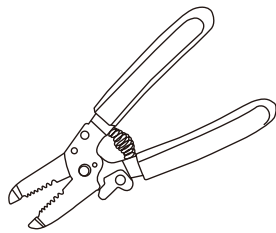

Wire stripper

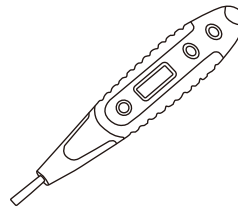

Test pencil

# Overall Sketch

Unit: mm

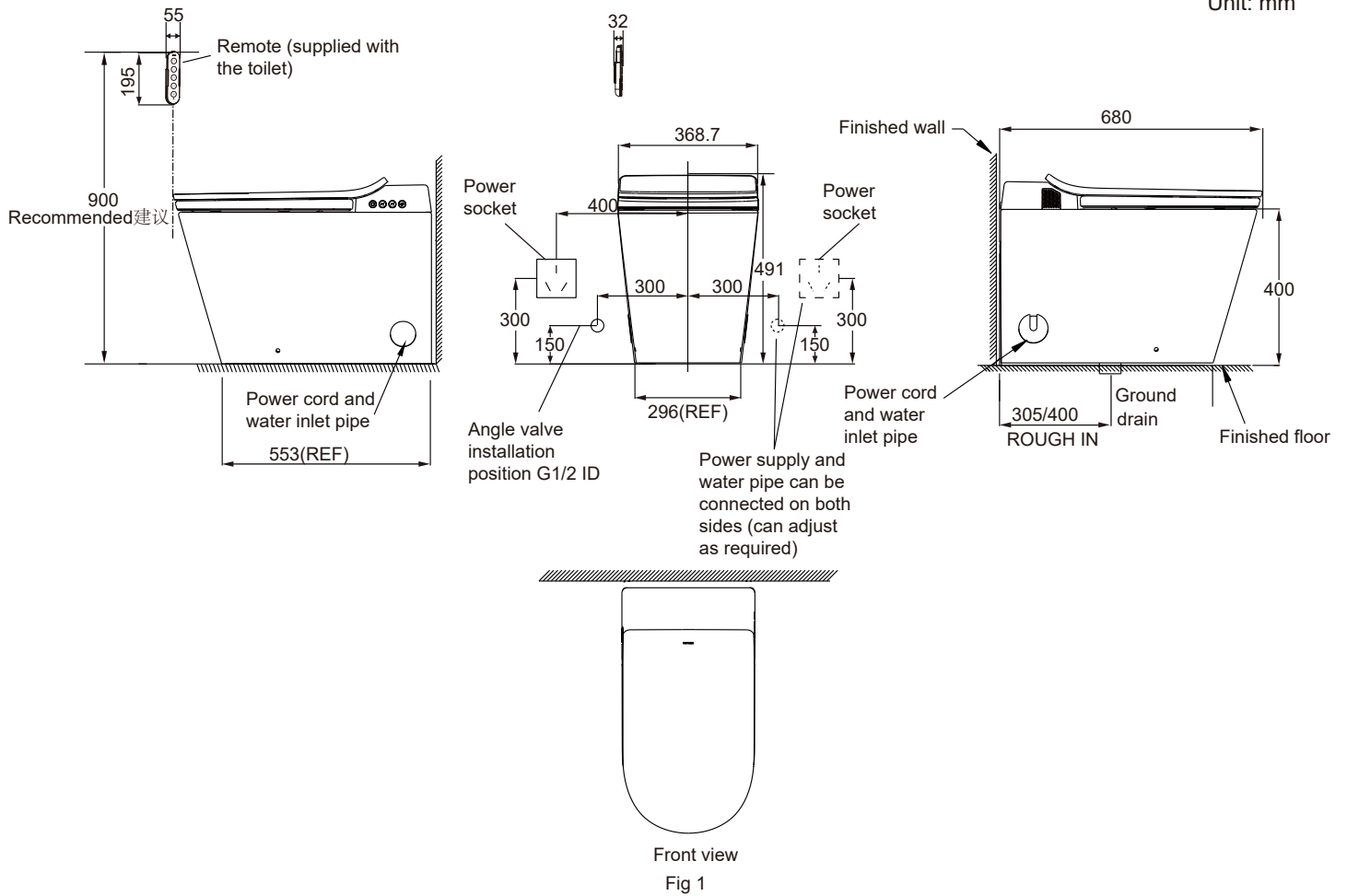

Kohler reserves the right to change marked dimensions without prior notice.

## SPECIFICATIONS

Flush volume	4.0L
Water efficiency grade*	Level II
Minimum rough-in	305mm/400mm
Water pressure	Min inlet water pressure 0.07MPa(dynamic) Max inlet water pressure 0.74MPa
Rated voltage	220V~, 50Hz
Rated power*	1200W
Outline dimension	About 680mm x 368.7mm x 491mm
Product weight	About 43kg
Inlet water temperature	1-35℃
Operation environment	1-40℃

**NOTE: Refer to “Homeowners Guide” for detailed specifications of the toilet.**

\* The description of water efficiency label marked on intelligent toilet: water efficiency label represents a compliance mark of the water efficiency grade etc. performance of intelligent toilet.  
 \* Power value testing condition: dynamic pressure 0.2MPa, inlet water temp 15℃, Before the test, turn off the seat temperature setting, run seat temperature to the stable status. Deactivate water temperature setting and run water temperature program to the stable status.

## PREPARATIONS BEFORE INSTALLATION

A. Hold the rim of the vitreous shell and take the toilet out.

**WARNING:** Risk of personal injury and product damage! Please do not hold the rim of the bidet seat when lifting the toilet. As the toilet is heavy, please seek help if necessary.

**Note:** Do not remove cover and seat protection bag during installation process.

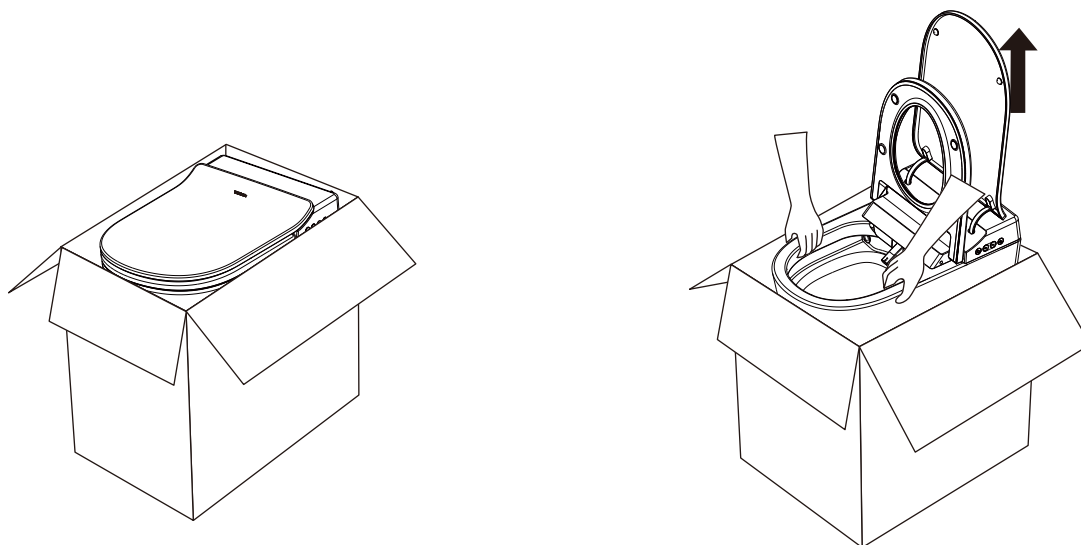

Fig 2

B. Place an 800mmX800mm cushion on the floor, take the toilet out from the carton then place on cushion.

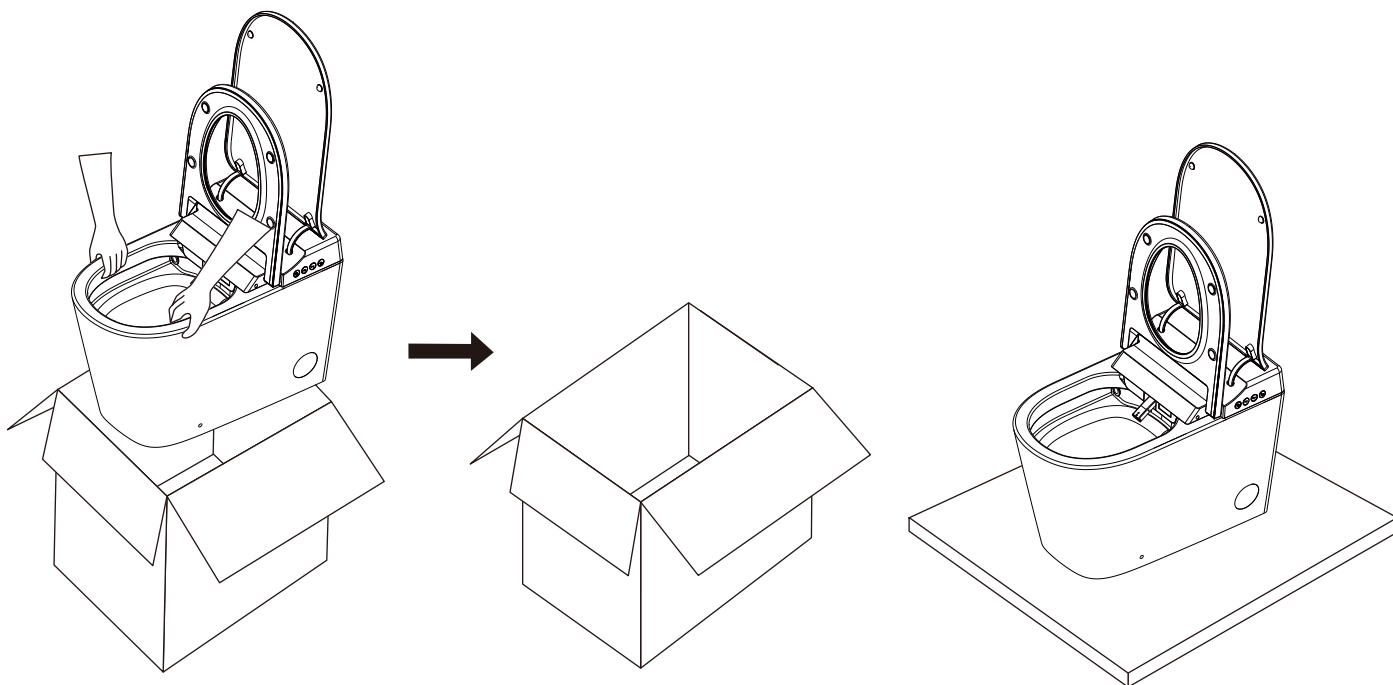

Fig 3



- C. 1. Confirm the drain hole center and mark down the “+” centerline perpendicular to the finished wall.  
2. Confirm the toilet drain hole center and mark down the centerline on front, back, left and right outside of toilet.  
3. Make sure the toilet is aligned to the drain hole centerline on the finished floor. Mark down the left and right holes.

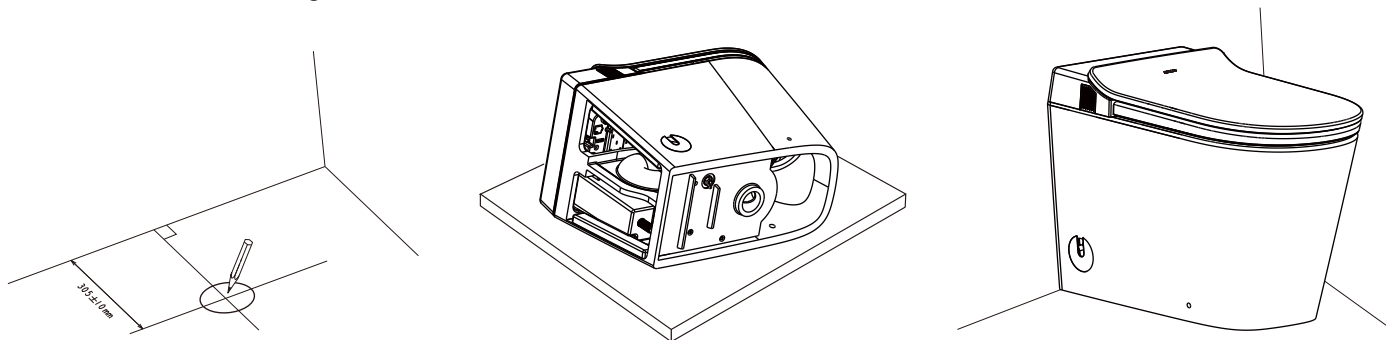

Fig 6

- D. Drill 2 holes according to the location recorded in step C and insert two plastic inserts and T-bolts.

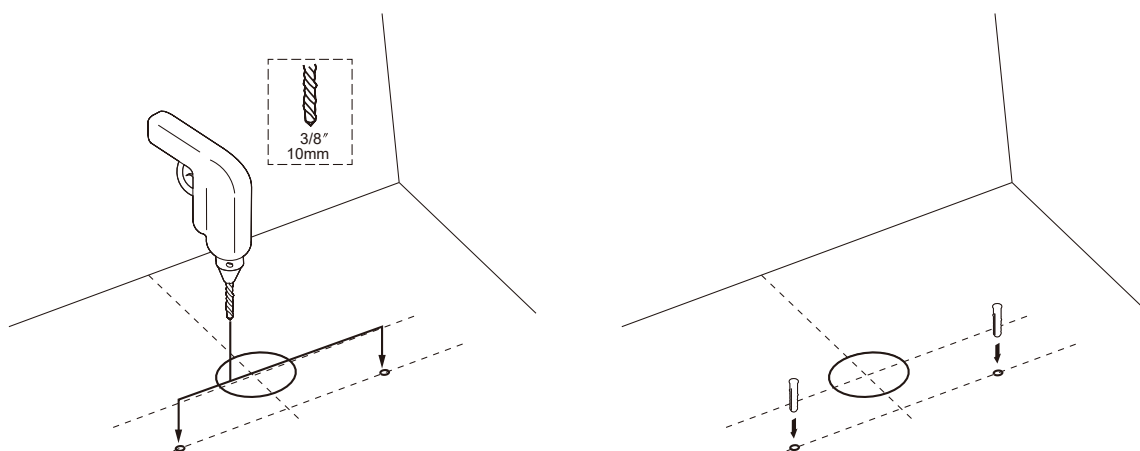
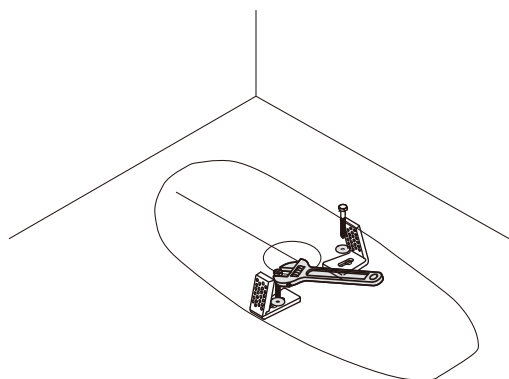

Fig 7

- E. T-bolt bracket installation (bolts and bracket will be provided).



## F. Wax installation

1. Align wax center with floor drain hole and place on floor.

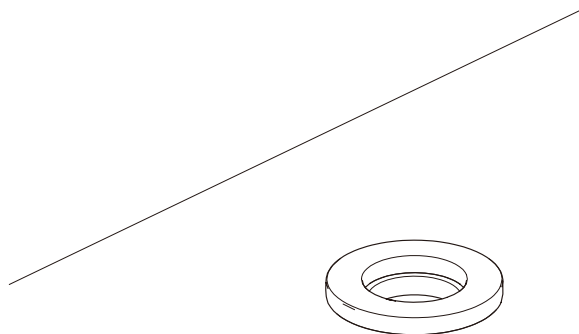

---

## G. Angle valve installation

1. Wrap angle valve by PTFE TAPE and connect with water hole on the wall.

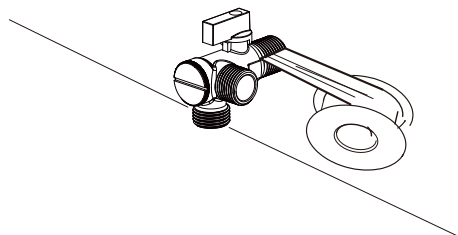

2. Angle valve switching method

Turn clockwise is OFF, turn counter-clockwise is ON.

**Note: After the angle valve is connected, discharge water completely.**

## I. Inlet connection

Connect the inlet pipe to the T-joint.

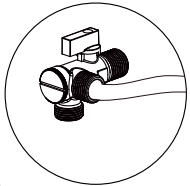
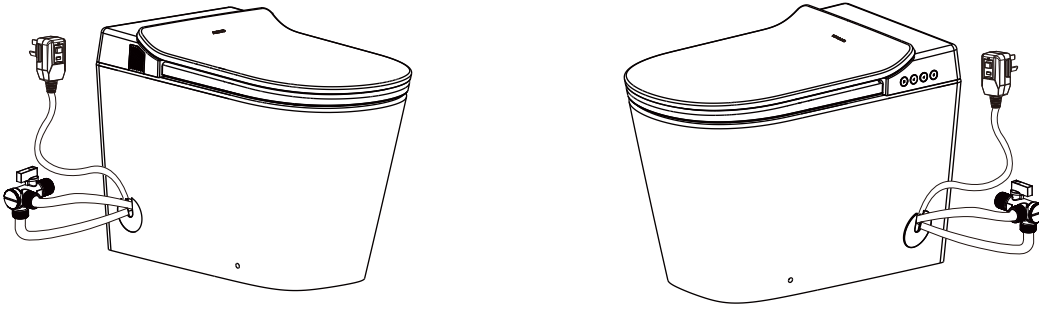

Connect water tank inlet pipe

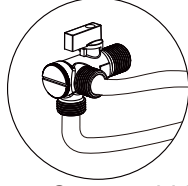

Connect bidet inlet pipe

**Note: When wires and water pipes are adjusted to the other side, mind the correct directions of the wires and pipes at the bottom of the toilet. Make sure that water flow in water pipes run smoothly without clogging.**

Replace the ceramic cover

- Hold the bottom of the ceramic cover and take out the notched ceramic cover.

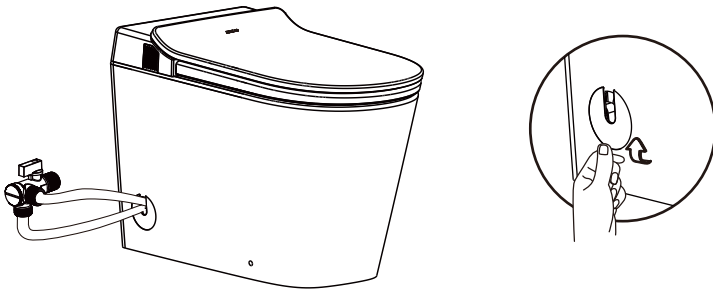

- Align with the round hole and push inwards. Put one part of the ceramic cover into the round hole first and then push the other part.

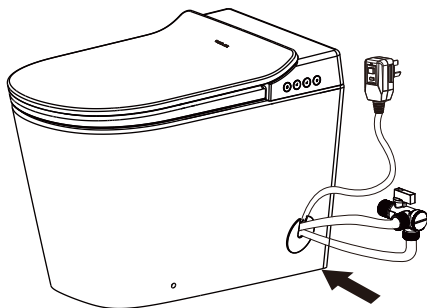

## J. Power connection

 Warning: plug in the power cord. Socket without grounding wire is not allowed.

---

## K. Power on and water on test

1. Water on first and then power on after installation.
  2. Open inlet valve, plug in the socket. Toilet start water and power self-inspection, fill water tank; when hearing one “Beep”, indicate self-inspection is completed and the toilet is ready for use. Specific usage refers to Homeowners Guide.
  3. Refer to flush water and power on inspection manual to confirm normal flush status.
- 

## L. Secure vitreous

1. Carefully screw the bolts into the bracket until toilet completely fastened. Tighten screws from left and right alternately to prevent the toilet deviate from the center. Then tighten the nut. Do not over tighten the screws.

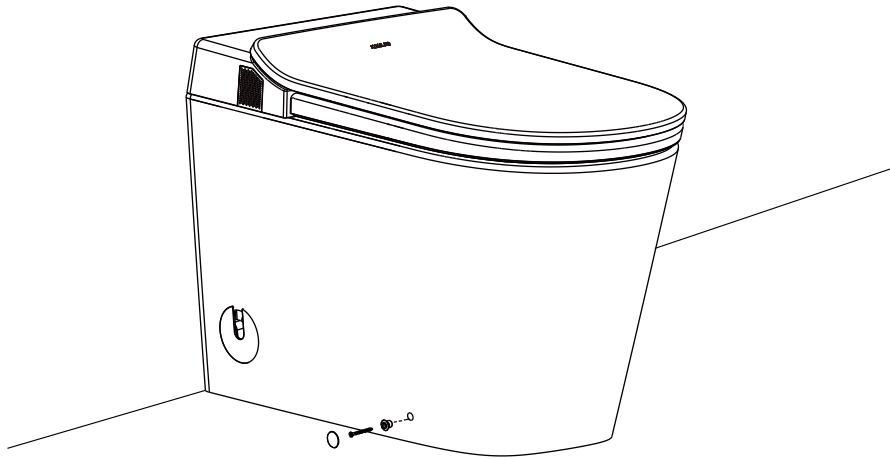

2. Apply silicon grease around the vitreous.

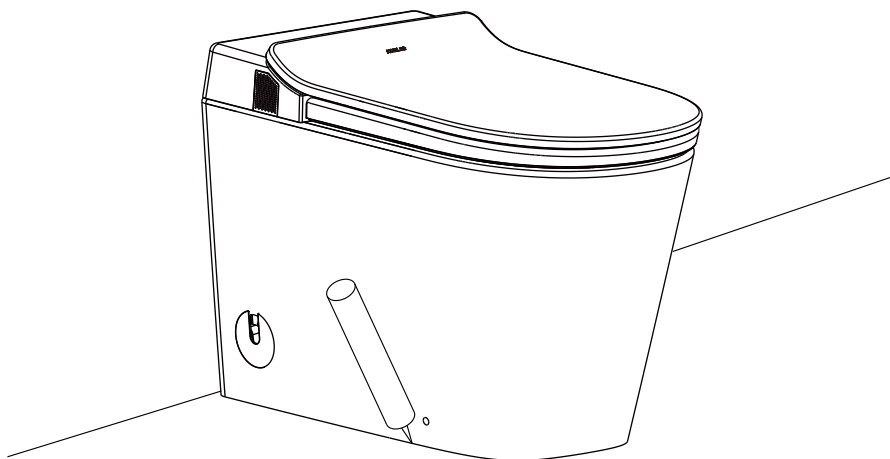

M. Emergency battery pack should not be installed with production together, it's only for emergency flush. Detailed see Homeowners Guide “Emergency flushing”.

---

## Installation of remote holder

NOTE: If the wall for installation is made of special material (such as wood board, density board and etc.), proper fixing methods shall be adopted.

NOTE: The place to install the remote shall not be easily splashed by water.

Choose a mounting location for the remote holder that is easily accessible while sitting on the seat.

Drilling two holes with depth larger than 45mm on the wall by drill with a diameter of 6mm in accordance with the position of screw holes on the remote holder, and then installs the expansion tube into the holes.

Place the installation holder on the fixing hole;

Fix the holder with screws and install it.

Install the screw covers on the screws;

Place the remote on the holder.

**Note: The double-sided tape on the back of the remote holder only serves as a pre-positioning for installation. Use the screws provided in the accessory package for final and reliable fixation.**



Fig 8

Installation steps:

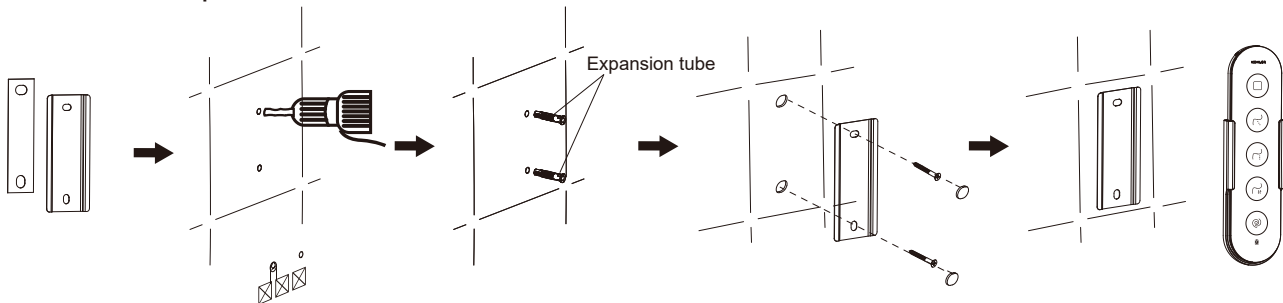

Fig 9

## Preparations before the initial use

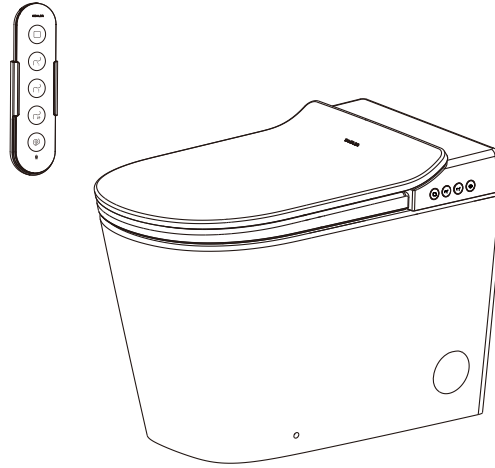

Fig 10

Confirm if water inlet valve is open.

Confirm power is connected properly.

Confirm battery has been installed in the remote docking station properly.

Make sure there is no any obstacle in front of the product.

Wait until the main unit completes the self-test. It is normal that motor rotation sounds and water flow sounds can be heard during this period.

When used for the first time, the product has factory settings.

### Front wash:

- Water temperature: medium
- Spray intensity: medium
- spray position: middle
- Pulsating mode: off

Ring temperature: medium  
Energy saving: off

### Rear wash:

- Water temperature: medium
- Spray intensity: medium
- spray position: middle
- Pulsating mode: off

Automatic UV sanitation: on  
Automatic deodorization: on  
Long sitting reminder: off  
Automatic water temperature and ring temperature adjustment: off

The aforesaid settings are available for the model with complete functions. Refer to the product configuration table for different specifications of various models.

# Trouble shooting

This guide of trouble shooting is for general help only. Authorized representatives or qualified electricians of Kohler Company shall be able to solve all electrical failures. If you want to know about the service of warranty, please contact local dealers or wholesalers.

Symptoms	Possible Causes	Recommended Actions
1. Toilet does not work	A. Power failure B. Plug not connected or no power to socket C. The leakage circuit breaker on plug does not reset D. Product is on standby mode	A. Wait until the power is restored B. Plug in or detect the socket C. Press Reset button on the plug D. Press “⊖” button at the side panel
2. The toilet does not flush	A. Water failure B. Tee valve for water supply is closed C. Power failure D. Product is at standby mode E. Wash mode is in progress F. Auto-flushing is deactivated	A. Wait until the water supply is restored B. Open the tee valve for water supply C. Wait until the power is restored or review manual flush, manual flush or flush by using the basin D. Press “⊖” button at the side panel E. Perform after flushing operation completed F. Review “Remote Control user guide”
3. Wash mode is abnormal	A. Water failure B. Tee valve for water supply is closed or not opened completely C. Not yet seated or current sitting posture unable to be sensed by the seat D. Filter screen is blocked E. Insufficient water pressure	A. Wait until the water supply is restored B. Fully open the tee valve for water supply C. Seated or adjust your sitting gesture D. Review the section of “Washing the filter screen” E. Check bend problem on inlet hose, if so, adjust hose
4. Flush function stops in operation process	A. Flushing mode stops automatically after continuous flushing for 5 minutes B. The seat is unable to sense human body	A. If necessary, press the flushing button again B. Adjust your sitting gesture or sit on the toilet again
5. The wash mode runs even when unseated	A. The seat is covered by foreign matters or the seat is wet	A. Remove the foreign matters or dry seat
6. Dryer fan stops in operation process	A. The dryer fan stops automatically after continuous usage for 4 minutes B. The seat is unable to sense human body	A. If necessary, press the dryer button again B. Adjust your sitting gesture or sit on the toilet again
7. Deodorization fan does not work	A. Stop button is pressed by mistake during operation B. Automatic deodorization disabled	A. If necessary, please unseat for about 2S and then sit on the toilet again B. Review “Remote Control user guide”
8. Intelligent deodorization not work	A. User sits on the toilet B. The seat is covered by foreign matters or the seat is wet	A. Please close the cover and reactivates the UV sterilization again when unseated B. Remove the foreign matters or dry the seat
9. Remote not work	A. Battery exhausted B. Battery polarities are mounted reversely	A. Replace with new batteries B. Reinstall properly

<p>10. Remote control fails to connect to toilet</p>	<p>A. Lower battery  B. The remote control is too far from the toilet  C. The toilet is not powered up  D. The toilet is on standby mode  E. The toilet is not connected to the remote control</p>	<p>A. Review "Usage and replacement of battery for remote control" chapter and replace battery accordingly  B. Review "Communication between remote controller and the toilet", and approach to the toilet  C. Power on the toilet  D. Press "⊖" button on side panel or seated  E. Review "Communication between remote and toilet" and connect toilet and remote accordingly</p>
<p>11. The seat is not warm</p>	<p>A. Remote seat temp set too low  B. Toilet is on standby mode  C. The system enters the energy saving mode</p>	<p>A. Set seat temp to proper dial  B. Press "⊖" button at the side panel  C. Exit Energy saving mode, refer to the "Remote control setting instructions" section</p>

To repair this toilet, you must first:

Close the water supply valve if necessary.

## IMPORTANT CONSUMER INFORMATION

### CONSUMER RESPONSIBILITIES

If you live in a hard water area, make certain that the holes on the toilet rim are kept clean to ensure proper bowl flushing. Toilet bowl cleaners should be used at least once a week. Use a long-handled brush to clean the rim holes, and to clean as far into the trap as possible to prevent mineral deposits from forming.

Most toilet bowl cleaners are not harmful to the vitreous chin or the surface of the toilet bowl. Please follow the bowl cleaner manufacturer's instructions carefully.

Do not use abrasive cleaners or solvents.

 **WARNING:** Risk of property or product damage.

Kohler Company shall not be responsible or liable for any damage to these fittings caused by the use of cleaners containing chlorine (Calcium hypochlorite).

 **Warning:** do not use any hard setting material (cement mortar) while installing the toilet. Thermal expansion of hard setting material (cement mortar) will damage or crash the feet of toilet. Kohler will not be responsible for any damage because of using hard setting material (cement mortar) for toilet installation.

 **WARNING:** Risk of product damage.





Do not throw into the toilet what that will cause the toilet to block such as newspapers and sanitary towel. Do not bump the vitreous china with great force as it will cause damage and leaking.

Do not use product beyond the specified environment.

**NOTE:** Refer to "Homeowners Guide" for the cleaning and maintenance of toilet.

**NOTE:** Flush the water supply pipes thoroughly to remove debris. Product is designed for tap water or potable water.

## 注意

-  **警告：**本产品必须安全接地。只能连接到专用的220V~，50Hz，10A带接地故障断路器或接地漏电保护器的电路中。
-  **危险：**存在触电危险。操作前应切断电源。
-  **警告：**存在触电危险。只可连接至带接地故障断路器（GFCI）或接地漏电断路器（ELCB）保护的电路中。
-  **谨慎：**存在有害气体的危险。如果新坐便器不能立即安装，可在地面法兰孔上临时遮盖一块旧布。

注意：遵守所有的本地管道安装和电气规程。

注意：安装在浴室内的插座位置（如果有）距离浴缸或淋浴喷头至少应为一米。

- 遵守所有的本地管道安装规程和建筑规范。
- 仔细检查新坐便器有无损坏。
- 电源和水管应采用墙式安装方式。

 **警告：**触电、火灾或人身伤害的危险。

 **警告：**必须使用10A的插座。

## 安装之前

- 请仔细阅读本指引。以便熟悉所需工具、物料及安装程序。请遵照适用的章节来安装您的坐便器，以避免由于安装失当而导致不必要的损失。除了有关正确的安装方法之外，还务请详阅所有操作及安全指引。
- 本指引所载之一切资料，均以印刷时所有之最新产品情况为基础，科勒保留权利随时更改产品特性、包装或供应情况，恕不另行通知。
- 本指引也包含了有关护理、清洁及保养等重要资料—请交予用户保存。
- 我们感谢您对科勒质量的信任。在您开始安装之前，请您花上几分钟时间来阅读这本手册。如果您在安装或性能方面遇到问题，务必请您与我们联系。再次感谢您选择科勒公司。
- 安装前，请确保坐便器安装所需要的空间，并不会影响到门的开关。
- 在安装本产品的同一房间中，需要在触手可及的位置安装一个止水阀，用于紧急情况下，无需借助工具即可切断本产品的进水水路；否则本产品的意外故障可能会导致用户损失。
- 确认出水坑距。坑距需满足305~400MM。如未满足，可能会影响安装。
- 确认出水接头距离完工墙面凸出不超过3mm。沉入完工墙壁不超过5mm。如未满足，可能会影响安装。
- 推荐使用内径DN15mm或以上的主水管。
- 请不要使用科勒不推荐的附件，如角阀等。
- 为了达到更好的冲洗效果，用户在安装进水管如PPR管的热熔连接时，应尽量避免明显的缩径或热熔挤出物堵塞部分管道等现象，并确保连接后进水管内径不小于15mm。
- 推荐电缆线规格1mm<sup>2</sup>—2.5mm<sup>2</sup>硬线，电路中需有220V~，50Hz，10A或以上接地故障断路器或接地漏电保护器。
- 用户切断电源后，如须再次接通电源，请务必听到“滴...”提示音结束后，再接通电源。
- 器具必须正确接地。
- 固定布线中必须配有触电开距提供在过电压等级III条件下全断开的装置。

## 所需工具及材料 (不随货供应)

电钻及配套钻头、螺丝刀 (十字, 一字, 梅花头)、剥线钳、剪刀、活络扳手、美工刀、笔、钳子、卷尺、测电笔、生料带

其他

垫子或防护材料

胶带

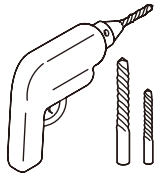

电钻及配套钻头

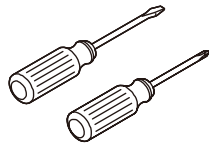

螺丝刀

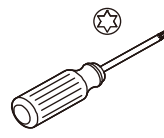

梅花头螺丝刀

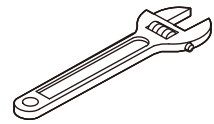

活络扳手

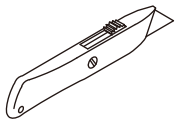

美工刀

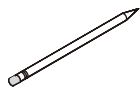

笔

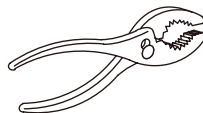

钳子



卷尺

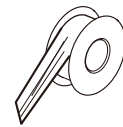

生料带

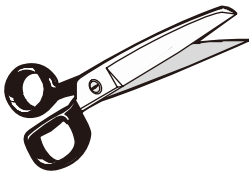

剪刀

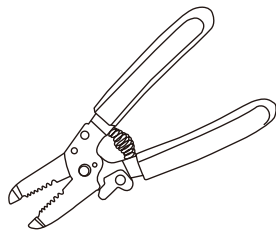

剥线钳

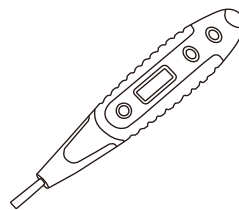

测电笔



## 安装前准备

A. 抓住陶瓷件的边缘，从包装箱中取出产品。

警告:人身和产品损害风险!向上提起坐便器时，请勿抓住智能盖板的边缘。由于坐便器较重，必要时请寻求他人帮助。

注意:在整个安装过程中，请勿取下盖板和座圈的保护袋。



图2

B. 在地面上放置一块800mmX800mm大小的软垫，将坐便器从包装箱中取出放在软垫上。

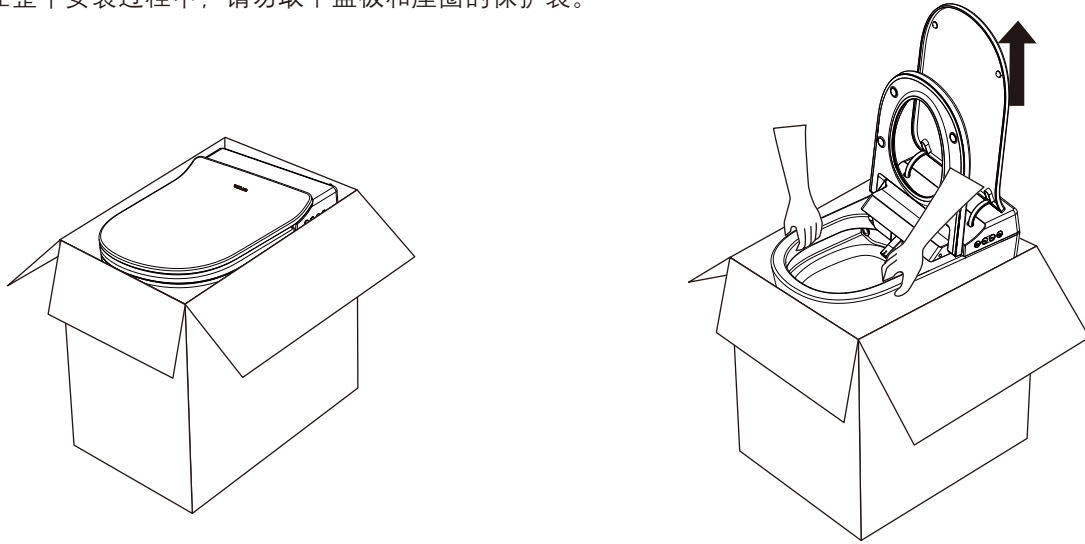

图3

## A. 拆除旧坐便器(如果有)

关掉供水源，给坐便器冲水，用海绵吸去坐便器内的剩余水份，拆除供水管止水阀(如果有)，移开旧水箱和坐便器用涂油灰刀拆除地上的旧密封垫圈及坐便器法兰附件包，拆除及扔掉旧的T型螺栓。

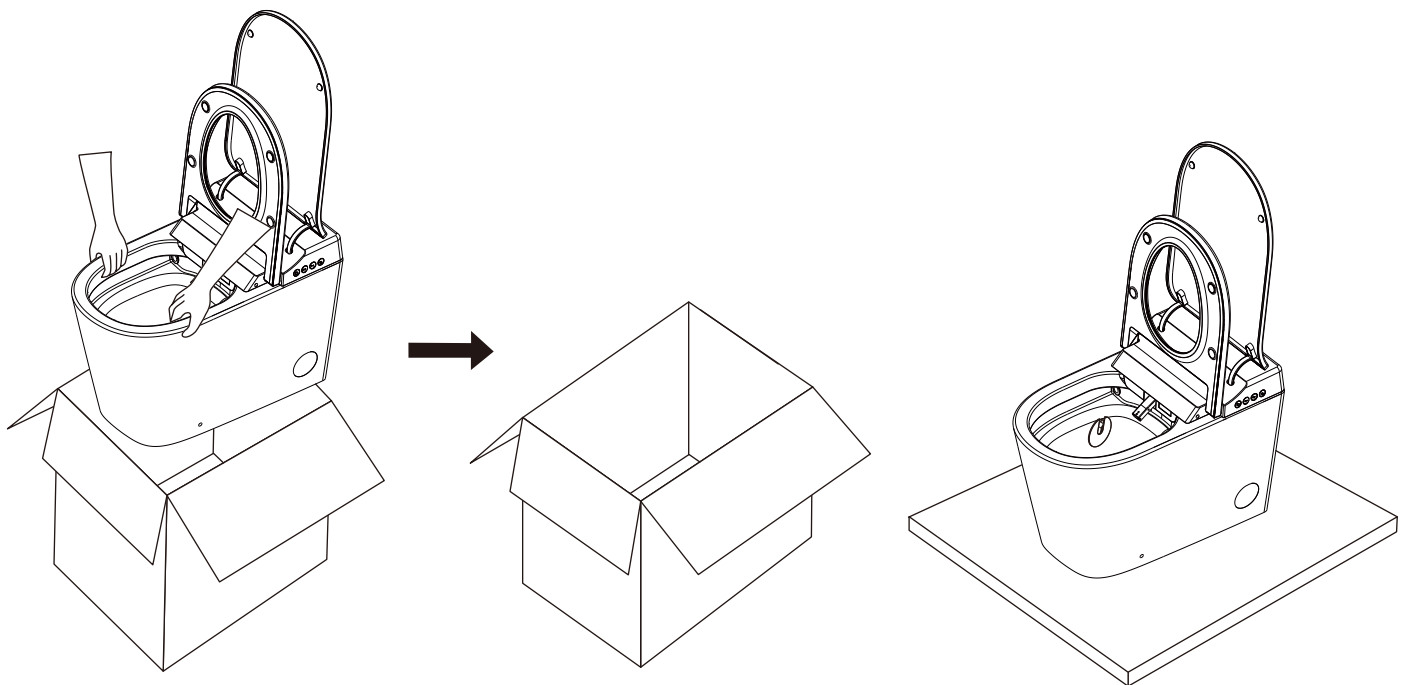
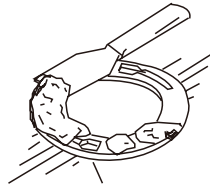

注意:如果不能即时安装新坐便器，请用碎布暂将法兰附件包堵住。



法兰附件包

图4

## B. 安装尺寸

-  **危险:** 存在触电危险。安装前应切断电源。  
注:本产品可安装于墙上式电源和水路管。安装方式在尺寸图中有标示。
-  **警告:** 存在触电危险。只可连接至带接地故障断路器(GFCI)或接地漏电断路器(ELCB)保护的电路中。
-  浴缸与花洒位置请远离带电部件(如遥控器、电源插座等)。如果是墙上式电源，需要使用防水、防溅的插座。

单位: 毫米



图5

- C. 1. 确定排污口中心点并垂直墙面划上十字线。  
2. 侧放坐便器，按陶瓷排污口找出前后左右中心标记，并记于陶瓷外侧壁上。  
3. 坐便器平稳对准地面上的中心线，记下左右地脚孔的位置。

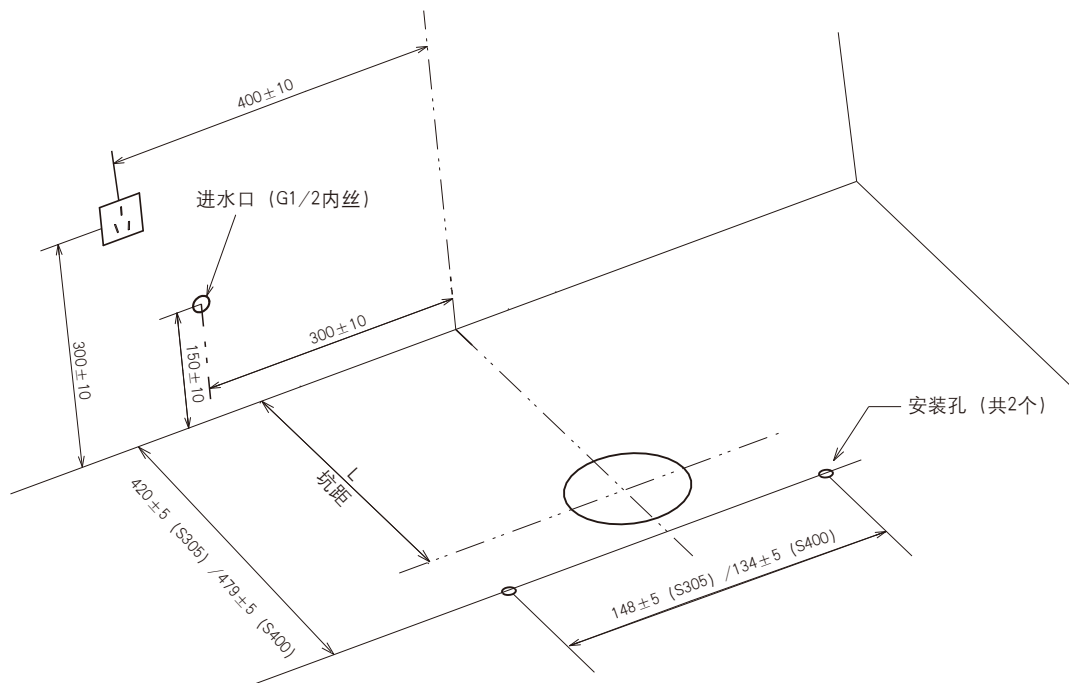

图6

- D. 根据步骤C记录的位置钻2个地脚孔，安装膨胀塑料。

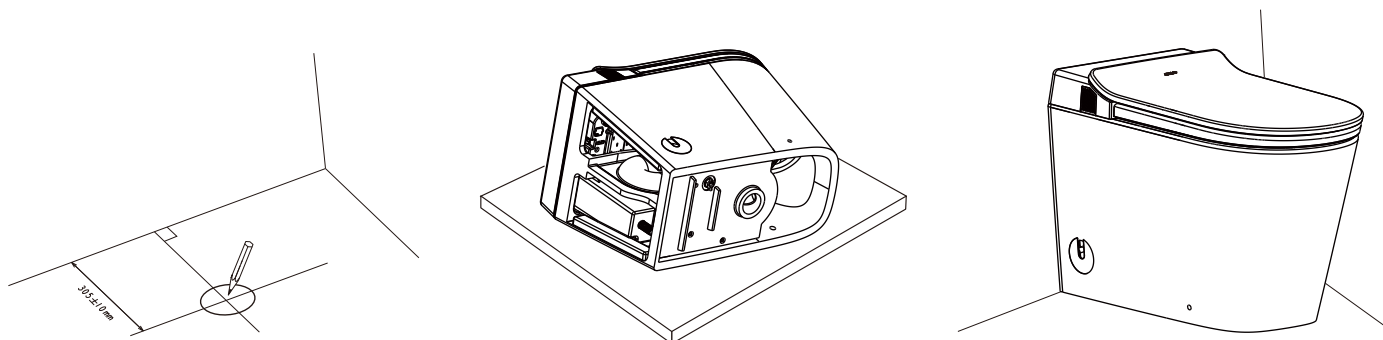

图7

- E. 地脚螺钉支架的安装(随整机配备螺钉及支架)。

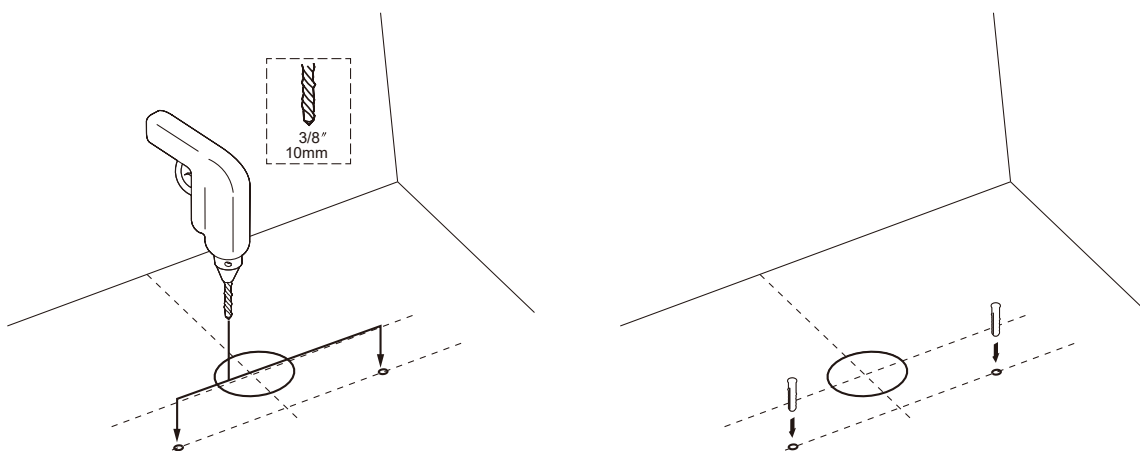
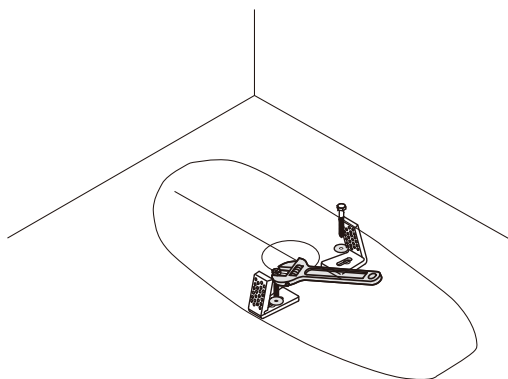

## F. 油泥安装

- 1、将油泥中心和地面排污口对齐，放于地面。

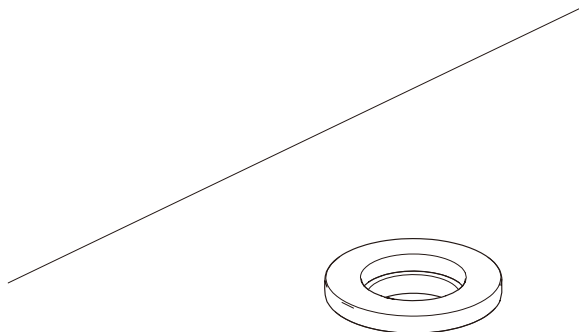

---

## G. 角阀安装

- 1、将角阀缠绕生料带后和墙面水孔相连。

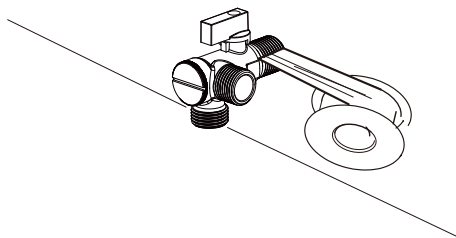

- 2、角阀的开关方法

顺时针为关，逆时针选择为开。

**注意：接好角阀之后，请排水至目视清洁为止。**

## H. 连接进水

整机进水软管连接到三通。

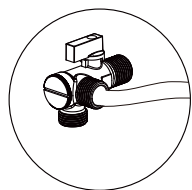
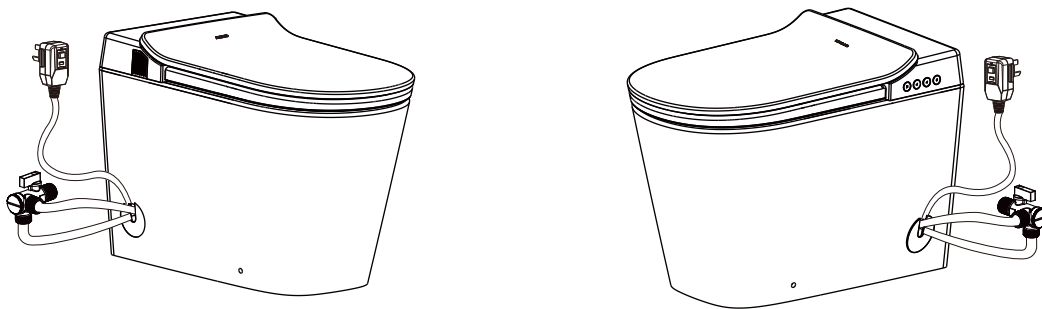

连接水箱进水软管

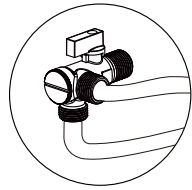

连接坐便盖进水软管

**注意:** 电线、水管调整到另一侧时, 注意调整电线及管路在陶瓷底部的走向, 水管需要能正常通水, 不能憋管, 导致水流不畅。

更换陶瓷装饰盖

- 拿住陶瓷盖板下方取出有缺口的陶瓷装饰盖。

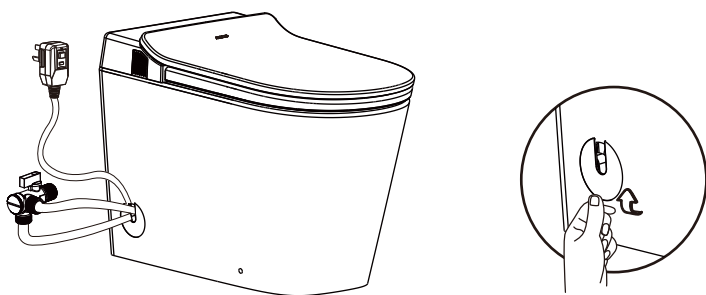

- 对准圆孔往里按压, 先把陶瓷装饰盖一侧放入圆孔, 再按压另一侧。

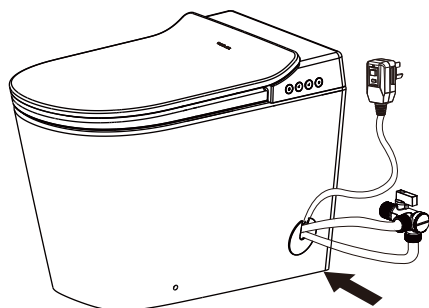

## I. 电源连接

 警告: 电源线插上插头不允许使用不带接地线的插座。

---

## J. 通水通电测试

- 1、安装后先通水，再通电。
  - 2、打开进水角阀，插上插头，机器开始进行通水、通电自检，水箱进水，等听到“滴”的一声响。自检完成，可以使用。具体使用方法参见用户手册。
  - 3、参看冲洗通水通电测试手册进行冲洗，确认冲洗正常。
- 

## K. 陶瓷体的固定

- 1、小心的将螺丝旋入支架中直到坐便器完全固定，左右交替旋紧以免坐便器偏离中心，拧紧后安装螺帽，请勿过度旋紧。

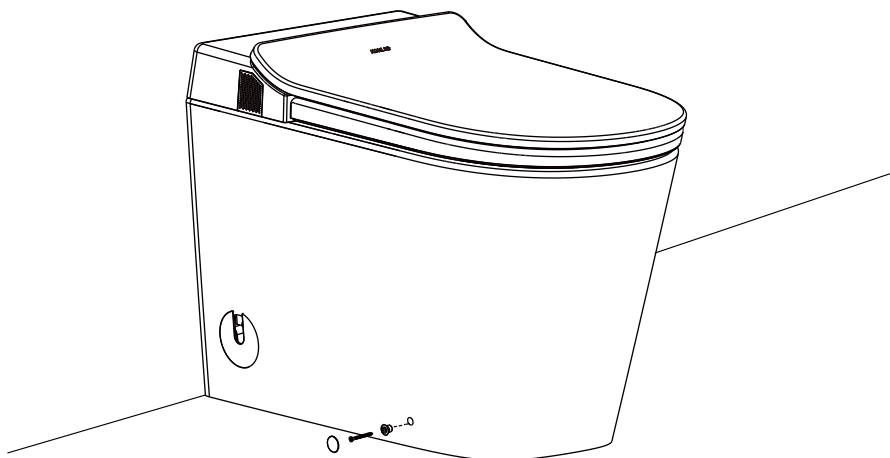

- 2、用硅胶给陶瓷周边涂上硅胶。

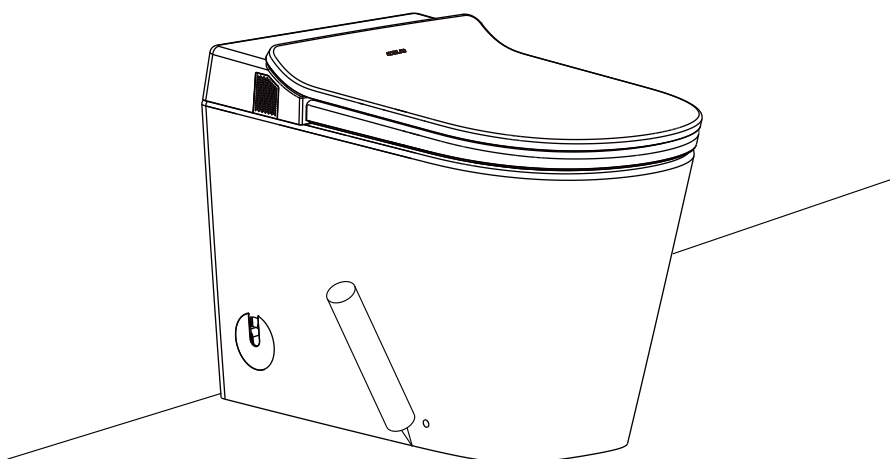

- L. 冲水电池盒仅在停电紧急冲水时使用，无需随整机一起安装，具体使用方法见用户手册“紧急冲水”。
-

## 安装遥控器支架

注意:如果安装墙面是特定材料(比如木板、密制板等)时,使用合适的固定方法。

注意:遥控器的安装位置应该是不易被水淋到的地方。

选择一个合适地方安装遥控器支架,此处应该是当你坐在坐便器上时,很容易用手操作遥控器的地方。

根据遥控器支架螺钉孔的位置,用直径6mm的钻头在墙上钻两个深度大于45mm的孔。在孔中装入膨胀管。

将安装支架放置在固定孔上。

用螺钉固定安装支架。

把螺钉盖装在螺钉上。

把遥控器放在支架上。

**注意:** 遥控器支架背面的双面胶仅起安装时的预定位作用,需要附件包里面配备的螺钉做最终可靠固定。



图8

安装步骤:



图9



图10

确认进水阀是否已打开。

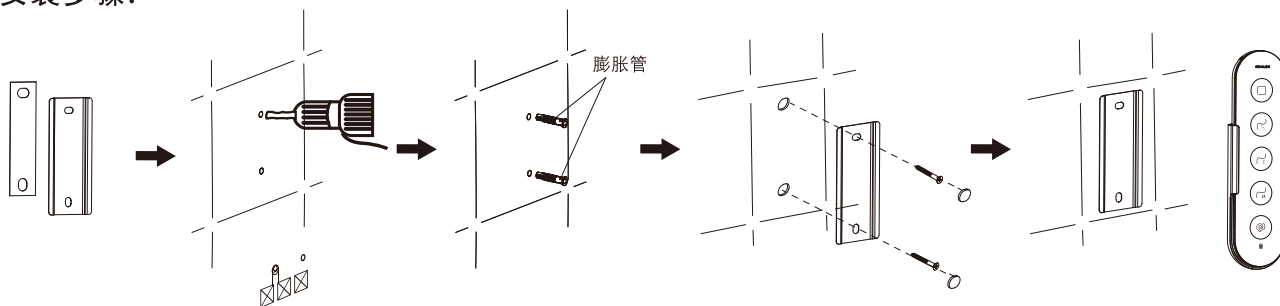
确认电源已连接。

确认遥控器充电座内已正确装入电池。

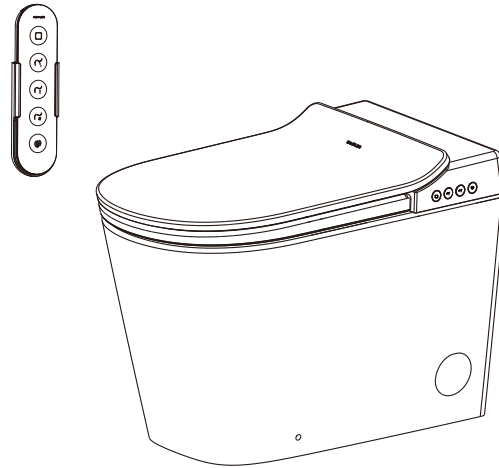
确认产品正前方没有障碍物。

等待主机完成自检。期间可听到电机的转动声和流水声，均属正常。

初次使用时为出厂设置状态：

女性冲洗：

- 水温：中档
- 水流强度：中档
- 冲洗位置：中档
- 脉冲模式：关

圈温：中档

节能功能：关

臀部冲洗：

- 水温：中档
- 水流强度：中档
- 冲洗位置：中档
- 脉冲模式：关

自动UV功能：开

自动除臭功能：开

长时如厕提醒功能：关

水温圈温自动调节功能：关

以上设置为全功能版本，具体型号的规格差异见产品配置表。

# 疑难解答

本指南仅作一般帮助之用。科勒公司授权的服务代表或者合格电工应当能够解决所有的电气问题。如需了解担保服务，请联系您当地的经销商或批发商。

现象	可能原因	建议措施
1. 坐便器不工作	A. 停电 B. 插头未插或者插座无电 C. 电源线插头上漏电保护开关未复位 D. 产品处于待机状态	A. 等到电力恢复 B. 插上插头或者检测电源插座 C. 按下插头上的复位按钮 D. 按一下侧面“⊖”按键
2. 坐便器不冲水	A. 停水 B. 供水角阀关闭 C. 停电 D. 产品处于待机状态 E. 清洗功能正在使用中 F. 自动冲水功能被禁止	A. 等到恢复供水 B. 打开供水角阀 C. 等待恢复电力或者查看“手动冲洗”部分进行手动冲洗或者用盆盛水冲洗。 D. 按一下侧面“⊖”按键 E. 待清洗功能完成再进行 F. 查看“遥控器设置指南”部分
3. 清洗功能无法正常使用	A. 停水 B. 供水角阀关闭或者未完全打开 C. 没有入座或者当前坐姿无法使座圈感应到 D. 过滤网阻塞 E. 供水水压不足	A. 等到恢复供水 B. 完全打开供水角阀 C. 请入座或者调整坐姿 D. 查看“清洗过滤网”部分 E. 检查进水软管是否折弯过急，如折弯过急，请调整软管
4. 使用过程中冲洗功能停止工作	A. 连续冲洗5分钟后冲洗功能自动停止 B. 座圈未感应到人体	A. 如需要，请再次按下冲洗按键 B. 变换坐姿或者重新入座
5. 人体未入座时也能使用清洗功能	A. 座圈上有异物覆盖或者座圈是湿的	A. 移除异物或者擦干座圈
6. 使用过程中暖风机停止工作	A. 连续使用暖风功能4分钟，风机自动停止 B. 座圈未感应到人体	A. 如需要，请再次按下暖风按键 B. 变换坐姿或者重新入座
7. 除臭风机不工作	A. 使用过程中误按停止键 B. 自动除臭功能被禁止	A. 如需要，请离座2秒后重新入座 B. 查看“遥控器设置指南”部分
8. 智感除菌不工作	A. 有人坐在坐便器上 B. 座圈上有异物覆盖或者座圈是湿的	A. 请离座后关闭盖子再重新开启紫外线杀菌及关闭坐便器 B. 移除异物或者擦干座圈
9. 遥控器不工作	A. 电池电量耗尽 B. 电池极性装反	A. 更换新电池 B. 重新正确安装
10. 遥控器无法遥控坐便器	A. 电池电量不足 B. 遥控器离坐便器太远 C. 坐便器本机没有上电 D. 坐便器本体处于待机状态 E. 坐便器与遥控器未连接	A. 查看“遥控器电池的使用及更换”部分来更换电池 B. 查看“遥控器与本机的通讯”部分并靠近坐便器 C. 请给本体上电 D. 按一下侧面“⊖”按键或落座 E. 查看“遥控器与本机的通讯”部分，连接坐便器与遥控器

<p>11. 座圈不热</p>	<p>A. 遥控器的圈温设置太低          B. 坐便器处于待机模式          C. 整机进入节能模式</p>	<p>A. 将圈温设置到合适档位          B. 按一下侧面的“⊖”键          C. 退出节能模式，查看“遥控器设置指南”部分</p>
This area is intentionally left blank for troubleshooting steps		

### 用户责任

如果你居住地方的水质是硬性，你必须保持冲水孔清洁，令坐便器冲水正常。每星期应最少使用坐便器清洁剂清洁一次，用长把手的刷子清洁冲水孔，并尽量伸入排污管洗刷，防止矿物质积聚。

大部分厕所清洁剂都不会损坏坐便器表面的釉面陶瓷，但烦请遵照坐便器清洁剂生产商指引小心进行。

请勿使用腐蚀性清洁剂或溶剂。

 警告：提防楼宇受损或损坏产品。

科勒公司对此类因使用氯(次氯酸钙)而引致的冲水装置损毁，概不负责。

 警告：在安装本坐便器时切勿使用任何凝胶材料(水泥砂浆)。因为凝胶材料(水泥砂浆)的热膨胀可能使坐便器的脚部挤破或损坏。科勒对所有因为凝胶材料(水泥砂浆)安装而引起的坐便器破裂恕不负责。

 警告：提防损坏产品。

请不要向便器内冲入新闻纸、纸尿垫、妇用卫生巾等容易堵塞的物品。请不要用重力撞击陶瓷，以防止破损漏水不要在规定的使用环境外使用。

注意：智能坐便器的清洗和维护详见用户手册。

注意：一定要先彻底冲洗供水管以清除管道中的杂质，使用水源为自来水或可供饮用水。